

Targeted Constituents

<input checked="" type="radio"/> Significant Benefit		<input checked="" type="radio"/> Partial Benefit		<input type="radio"/> Low or Unknown Benefit	
<input checked="" type="radio"/> Sediment	<input checked="" type="radio"/> Heavy Metals	<input checked="" type="radio"/> Floatable Materials	<input checked="" type="radio"/> Oxygen Demanding Substances		
<input checked="" type="radio"/> Nutrients	<input checked="" type="radio"/> Toxic Materials	<input checked="" type="radio"/> Oil & Grease	<input type="radio"/> Bacteria & Viruses	<input type="radio"/> Construction Wastes	

Implementation Requirements

<input checked="" type="radio"/> High		<input checked="" type="radio"/> Medium		<input type="radio"/> Low	
<input checked="" type="radio"/> Capital Costs	<input checked="" type="radio"/> O & M Costs	<input checked="" type="radio"/> Maintenance		<input type="radio"/> Training	

Description

Oil/water separators (also called oil/grit separators because most designs generally remove coarse sediment) are intended to remove floating gasoline, oil, grease, light petroleum products and other floating liquids from stormwater runoff. Oil/water separators are especially applicable as pretreatment before detention ponds. See F-01 (Catch Basin Inserts / Media Filter) for similar structures which also have some capabilities for removing oil and grease. Various systems discussed in this BMP should be evaluated for targeted constituents, site area constraints, cost, frequency of maintenance, reliability, and inspection requirements.

There are two basic types of oil/water separators (conventional and CPI), as displayed in Figure F-02-1. Conventional separators rely upon gravity, physical characteristics of oil and sediments, and good design parameters to achieve pollutant removal. CPI separators contain closely-spaced plates which greatly enhance the removal efficiency for oils and grease. In addition, a wide variety of systems are commercially available in a variety of layouts, for which vendors have design data and procedures.

Selection Criteria

Oil/water separators are commonly used for industrial applications, which have a constant flow of known quantity. Separators are very efficient in these types of applications. However, it is much more difficult to remove smaller concentrations (such as 10 ppm) from stormwater runoff which has a much broader range of flows. Due to many unknown variables concerning oil and grease pollutants, theoretical equations for oil separation are not usually applicable for stormwater runoff. There are a wide variety of empirical guidelines when evaluating manufactured oil/water separators. The most important selection criteria are the long-term maintenance and operation costs, regular inspections, and cleanout procedures. The oil/water separator system should only be constructed if: 1) there is a maintenance plan to regularly inspect and maintain the oil/water separator on a long-term basis, and 2) there is an agreement or fiscal guarantee that the required maintenance resources will be available for the life of the system. Without regular inspection and maintenance, an oil/water separator will fail and generally create a worse pollution problem.

Another very important decision is whether to bypass large storm events around the oil/water separator without damaging the system, exceeding design flow capacity, or re-suspending collected pollutants. For larger storm events, stormwater runoff will become turbulent and remix the oil droplets. Large flows can also scour sediments that have been deposited on the bottom of an oil/water separator over the course of several months. Essentially, pollutant removal is only ensured when the oil/water separator is cleaned out regularly, and the sediments are properly analyzed and disposed.

Stormwater runoff is only detained briefly within oil/water separators because of size constraints for an engineered structure. Therefore, it is important that all factors leading up to the separator and also downstream from the separator are favorable for its effective operation. An oil/water separator is frequently used as the upstream pretreatment measure in a series of stormwater treatment BMPs, ahead of a detention basin or constructed wetland. Advantages of an oil/water separator may include:

- Efficient use of valuable space (since it is usually located underground)
- Does not require as much vertical drop as some other types of BMPs
- Easily accessible and easy to clean with proper equipment
- Reliable if carefully designed (including upstream and downstream reaches)

Oil/Water separators are ideal for the following situations:

- Parking lots, streets, driveways, truck loading areas
- Runways, marinas, loading wharves
- Gasoline stations, refueling areas
- Automotive repair facilities, oil-change businesses, fleet maintenance yards
- Recycling or salvage yards which accept automotive equipment
- Commercial vehicle washing facilities
- Pretreatment in combination with detention ponds, infiltration systems, constructed wetlands, etc.

Design and Sizing Considerations

A scientific basis for sizing oil/water separators relies upon the rising velocity of oil droplets and the rate of runoff through the system. However (other than stormwater from oil refineries), there is generally no relevant method for describing the characteristics of petroleum products in urban stormwater. It is known that conventional oil/water separators are probably not efficient for removing oil droplets with diameters smaller than 150 microns. For instance, Figure F-02-2 shows a size distribution for which a CPI oil/water separator would be more effective.

Therefore, design is performed on the basis of engineering judgment and guidelines. Design procedures for commercially available oil/water separators are usually given by simplified tables or graphs based on field testing and observed pollutant removal rates. It is desirable to maintain reasonable dimensions by bypassing larger flows in excess of the 1-year storm rainfall rates (preferably by placing the separator “off-line” rather than “on-line”). An off-line separator can be an existing or proposed manhole with a baffle or other control (shown in Figure F-02-3). Bypass mechanisms must minimize potential for captured pollutants from being washed out or re-suspended by large flows.

Some petroleum products may become attached to coarse sediments which are easily removed in the first chamber. A significant percentage of petroleum products also become attached to fine suspended solids and therefore are not removed by settling or flotation. Consequently, the performance of oil/water separators can be difficult to estimate prior to installation and monitoring.

Conventional Oil/Water Separator

Oil and water do not separate easily. By careful design of upstream and downstream reaches, it is possible to reduce turbulent flows, drop heights, mixing or swirling stormwater runoff, and excessive velocities. It is highly recommended that maximum subbasin size for an oil/water separator should be no larger than 1 acre; this will keep units to manageable sizes and allow for accurate monitoring of stormwater quality.

Figure F-02-4 (based upon Maryland standards and taken from Debo, Thomas, and Reese) shows a typical design for a conventional oil/water separator, with slightly different features than compared to Figure F-02-1 (based upon California standards). The basic flow layout of Figure F-02-4 provides: 1) uniform tranquil flow, 2) a trash rack or other narrow opening to prevent trash and debris from flowing through, 3) a chamber for settling sediments and solids, 4) a chamber to capture floating oil and grease, and 5) access for each chamber, preferably with steps and large openings. The first two chambers for Figure F-02-4 should provide at least 400 cubic feet of permanent pool storage per acre. Both chambers must be cleaned regularly to remove floating oils and grease from the top and sediments from the bottom. Perform maintenance by using a conventional vacuum truck for both chambers, being careful not to discharge any pollutants to the stormwater outfall.

Manufactured Oil/Water Separators

A few manufacturers of oil/water separators are included in this BMP. Manufactured separators should be selected on the basis of good design, suitability for desired pollution control goals, durable materials, ease of installation, and reliability. The product list is not intended to be inclusive, nor is it intended to be an endorsement for each listed product. It is merely a list of separator manufacturers that are known to work in the Tennessee area.

Manufacturers generally provide design methods, installation guidelines, and proof of effectiveness for each application where used. These structures tend to include innovative methods of providing high-flow bypass. However, it is incumbent upon the landowner to carefully investigate the suitability and overall trustworthiness of each manufacturer and/or subcontractor.

Examples of oil/water separators illustrated in this BMP include:

Figure F-02-1	Highland Tank (CPI unit)	www.highlandtank.com
Figure F-02-5	Vortechnics, Inc.	www.vortechnics.com
Figure F-02-6	CDS Technologies	www.cdstech-us.com
Figure F-02-7	Stormceptor Corporation	www.stormceptor.com
Figure F-02-8	H.I.L. Technology, Inc.	www.hil-tech.com
Figure F-02-9	BaySaver, Inc.	www.baysaver.com

Other manufacturers include:

Aquashield, Inc.	Aqua-Swirl Concentrator	www.aquashieldinc.com
Environment 21, LLC	Ecosep	www.env21.com
StormTreat System, Inc.		www.state.ma.us/step/stepasst.htm

Each manufacturer may specify its design based upon an average design storm in order to achieve the recommended pollutant efficiency, but it is recommended that the oil/water separator should capture and treat the 1-year design storm. Other storms which are mentioned in the vendor catalogs are also the 6-month design storm (80% of the 1-year storm) and the 3-month design storm (62% of the 1-year storm).

Coalescing Plate Interceptor (CPI)

The CPI separator requires considerably less space than a conventional separator to obtain the same effluent quality. The angle of the plates to the horizontal ranges from 0° (horizontal) to 60°, with a typical plate spacing of 1 inch. Stormwater will either flow across or down through the plates. A CPI oil/water separator is able to process smaller oil droplets by collecting them upon polyurethane plates or other materials. It is recommended that the design engineer consult vendors for a plate package that will meet site and flow criteria. Manufacturers typically identify the capacity of various standard units. The angle of coalescing plates to the horizontal may range from 0° to 60°. However, at an angle of 0°, the plates would be horizontal and subject to having sediment settle on them. At an angle of 45° to 60°, sediment would be able to slide off and collect at the bottom. The spacing between plates is usually about 1 inch. Select a likely length and width of coalescing plate, and then compute number of plates needed.

Check geometry and necessary volume to contain the coalescing plates. Allow 1 foot below the plates for sediment storage. Add 6 to 12 inches above plates for oil to accumulate, and then allow an additional 1 foot above that for freeboard. Include a forebay to collect floatable debris and evenly distribute flow if more than one plate unit is needed. Larger units have a device to remove and store oil from the water surface, such as a skimmer or vacuum. Plates are easily damaged when removed for cleaning. Install plates at an angle of 45° to 60° so that most sediments slide off. Placing plates closer together reduces the total volume, but may instead allow debris such as twigs, plastics or paper to clog plates. Use a trash rack or screen to reduce clogging.

Construction/ Inspection Considerations

Install oil/water separators to manufacturer's specifications.

Maintenance

Follow vendor recommendations for manufactured oil/water separators. The following general instructions may be used in absence of conflicting data or guidelines.

- Oil/water separators should be inspected on a regular basis (such as every three months) to ensure that accumulated oil, grease, sediment, trash and floating debris do not disturb the proper functioning of the system. Record observations in an inspection log and take pictures as necessary to document conditions. Make immediate repairs as needed, and make arrangements for cleanout if needed. Consider using a licensed commercial subcontractor, who may have special equipment and abilities to perform periodic cleanout on oil/water separators.

- Perform cleanout on regular basis using confined-space procedures and equipment as required by OSHA regulations, such as nonsparking electrical equipment, oxygen meter, flammable gas meter, etc. Remove trash and debris and dispose properly. Remove floating oil, grease and petroleum substances using special vacuum hoses; treat as hazardous waste. Sediments may also contain heavy metals or other toxic substances and should be handled as hazardous waste. Removal of sediment depends on accumulation rate, available storage, watershed size, nearby construction, industrial or commercial activities upstream, etc. The sediment composition should be identified by testing prior to disposal.
- Some sediment may contain contaminants for which the Tennessee Department of Environment and Conservation (TDEC) requires special disposal procedures. Consult TDEC - Division of Water Pollution Control if uncertain about what the sediments contain or if it is known to contain contaminants. Generally, give special attention or sampling to sediments accumulated in industrial or manufacturing facilities, fueling centers or automotive maintenance areas, large parking areas, or other areas where pollutants are suspected to accumulate.

Cost Considerations

Varies, depending on manufacturer.

Limitations

- There is usually uncertainty about what types of oil or petroleum products may be encountered. A significant percentage of petroleum products are attached to fine suspended solids and therefore are not easily removed by settling.
- The design loading rate for oil/water separators is low; therefore, they can only be cost-effectively sized to detain and treat nuisance and low storm flows and particularly first flush volumes. It is usually not economical or feasible to size an oil/water separator to treat a design storm with a return period longer than 1 year. Oil/water separators require frequent periodic maintenance for the life of the structure. Maintenance can be minimized (and performance can be increased) by careful planning and design, particularly upstream and downstream from separator.
- It is difficult to remove small concentrations (such as 10 ppm) from stormwater runoff which has a broad range of flows.
- The performance of oil/water separators can be difficult to estimate prior to installation and monitoring.

Additional Information

See attached figures.

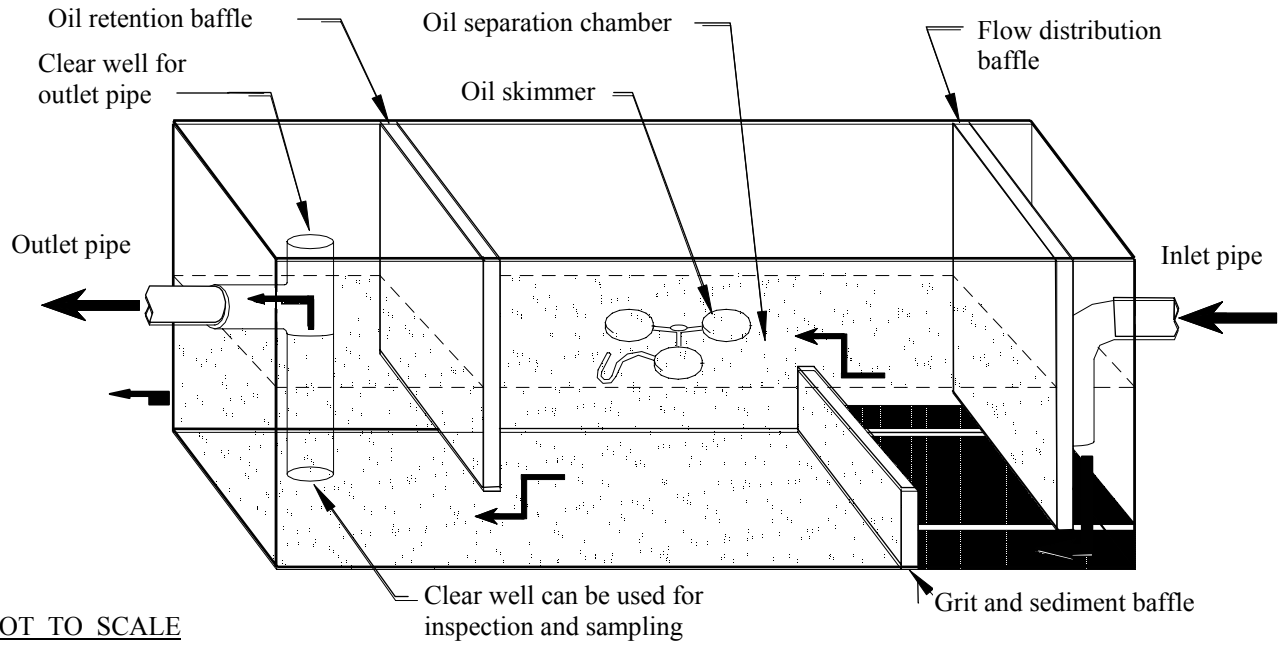

NOT TO SCALE

Conventional Oil/Water Separator

Provide access hatches or manhole covers for each compartment of an oil/water separator. Size openings to adequately convey all expected maintenance equipment and tools.

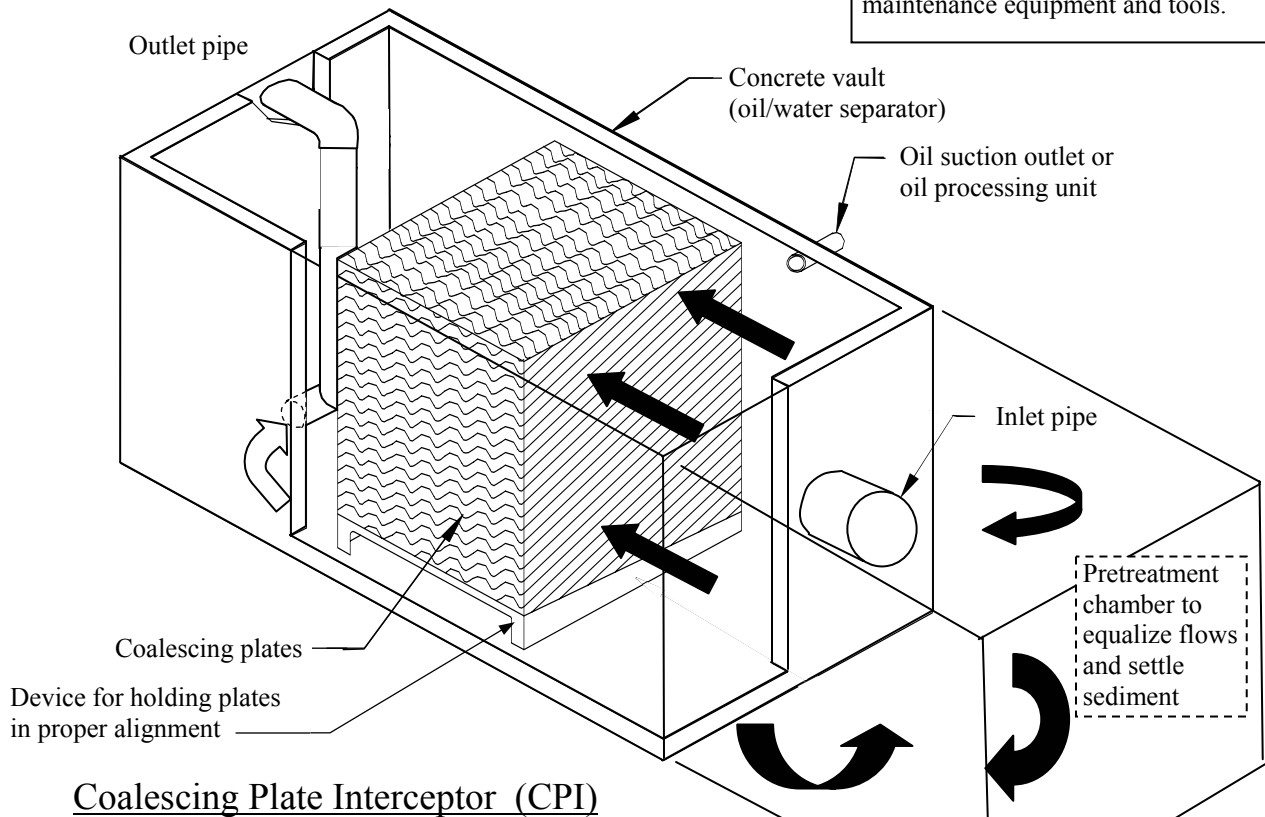

Coalescing Plate Interceptor (CPI)

**Figure F-02-1
Typical Oil/Water Separators**

Typical manufacturer:
Highland Tank & Mfg. Company

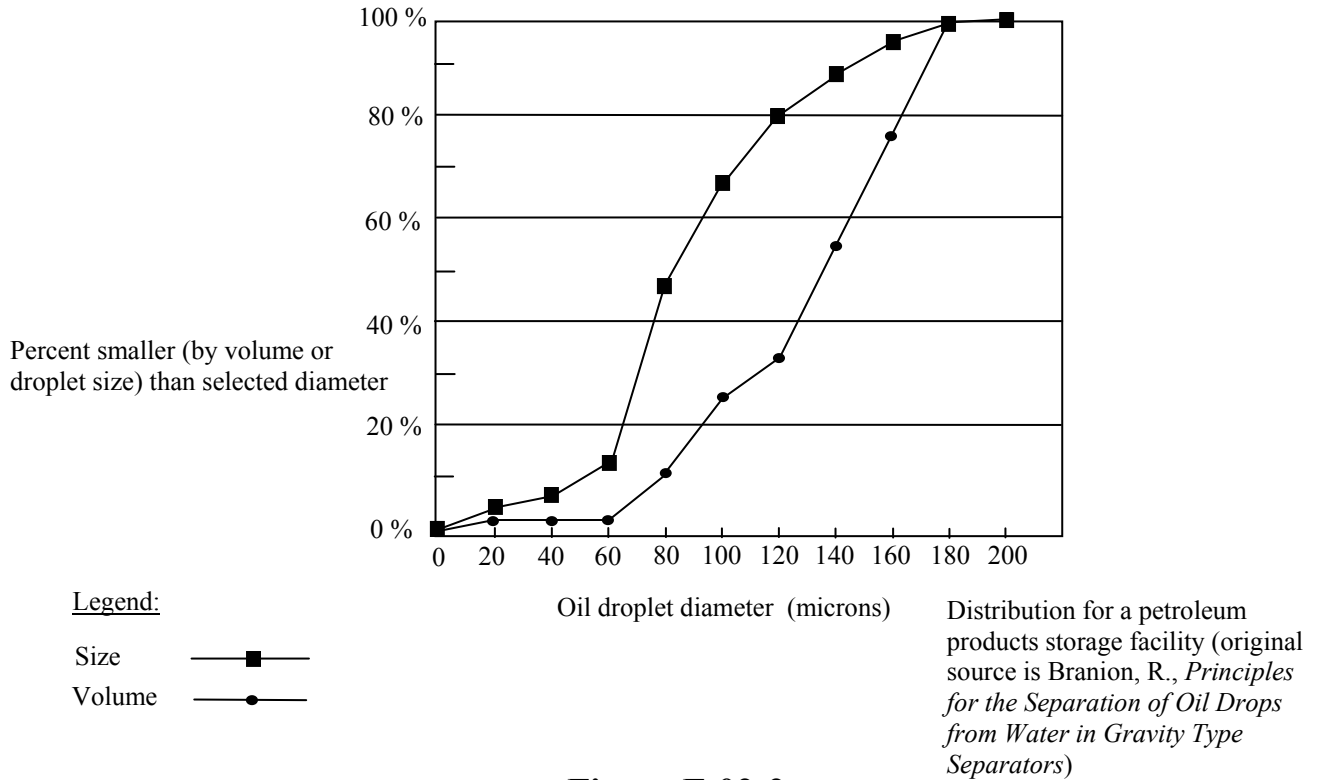

Figure F-02-2
Typical Size and Volume Distribution of Oil Droplets

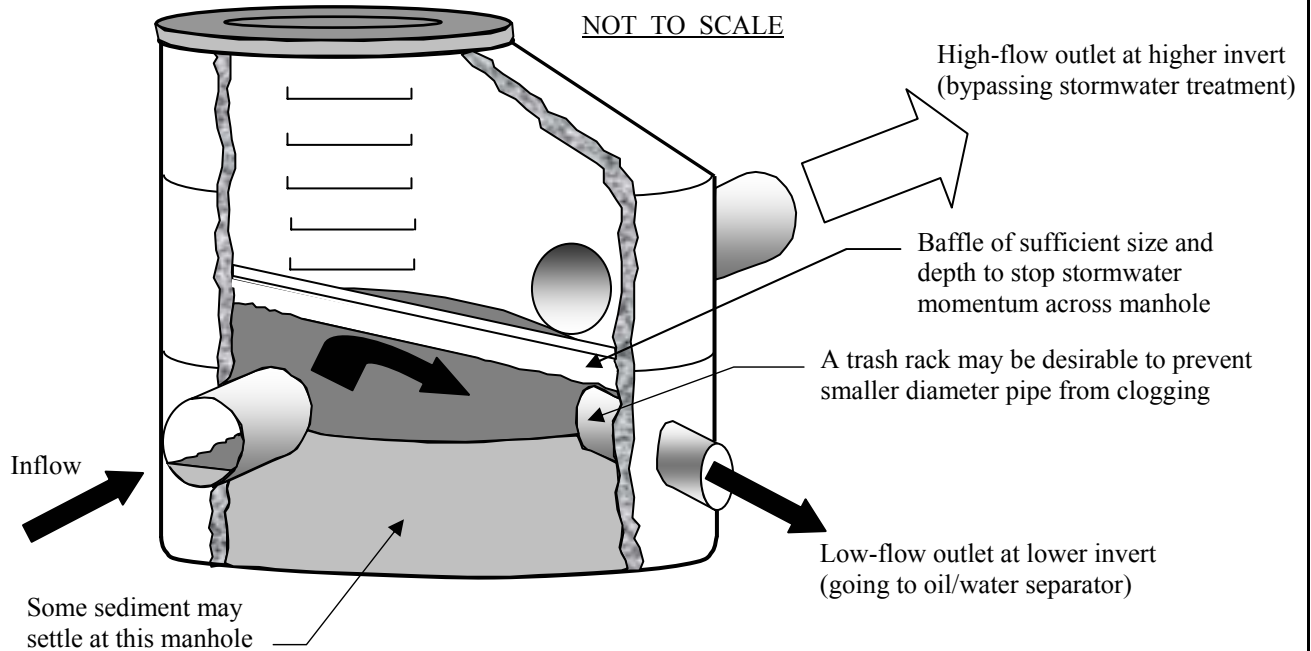
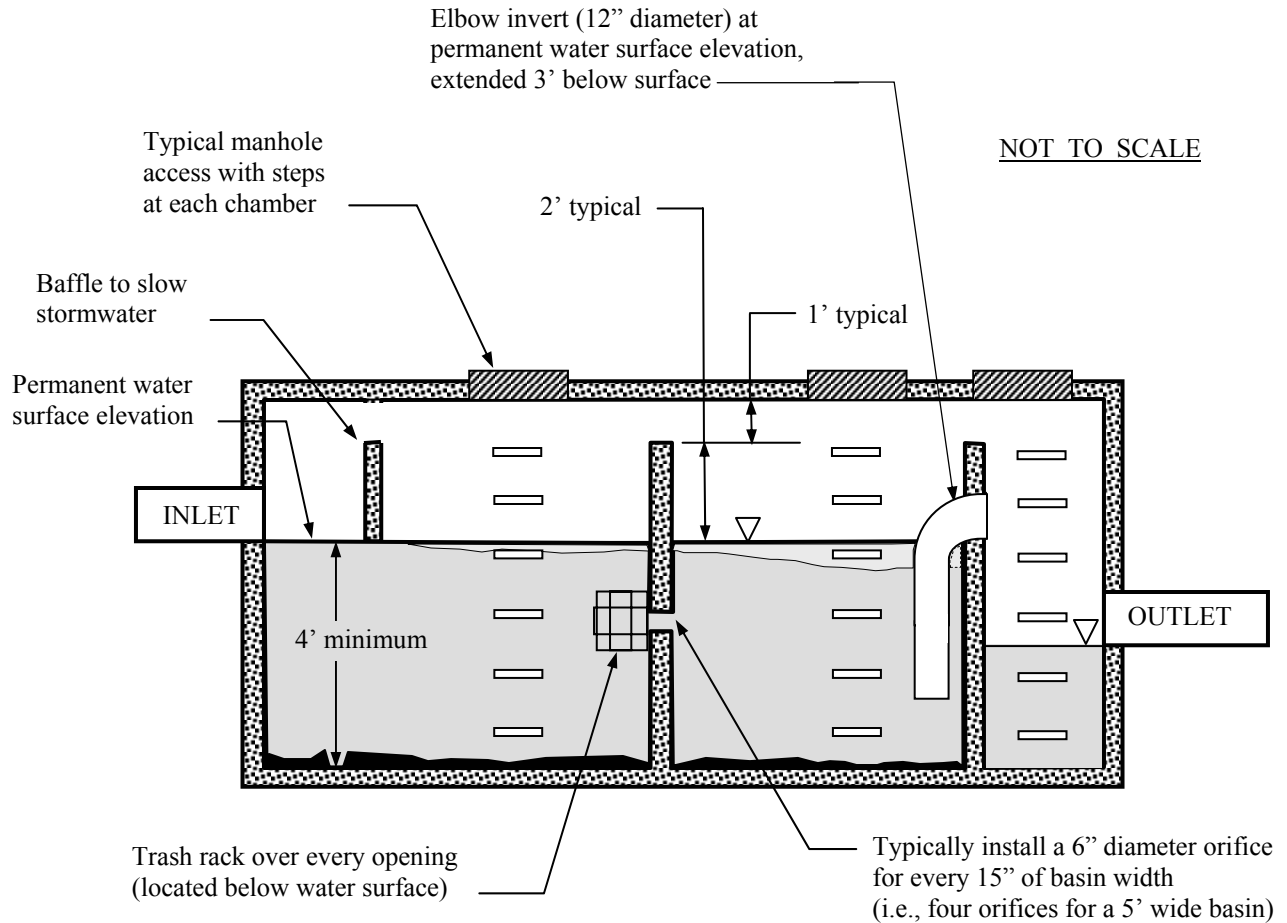

Figure F-02-3
Typical Stormwater High-Flow Bypass Manhole



Notes:

1. Provide low velocities entering the oil/water separator, and minimize opportunities for turbulence and mixing. Prevent backwater conditions downstream from the oil/water separator.
2. Minimum permanent pool storage shall be 400 cubic feet per acre of contributing drainage area.
3. Place 6" diameter orifices and 12" diameter pipe elbows across the internal walls to distribute flow evenly across the separator. Reduce or eliminate dead spots (or ineffective flow areas) in order to increase pollutant removal.
4. Label manhole lids so that the structure is easily identified as an oil/water separator. It may be necessary to control the type of truck traffic that is allowed to travel or park over a large oil/water separator.

**Figure F-02-4
Conventional Oil/Water Separator**

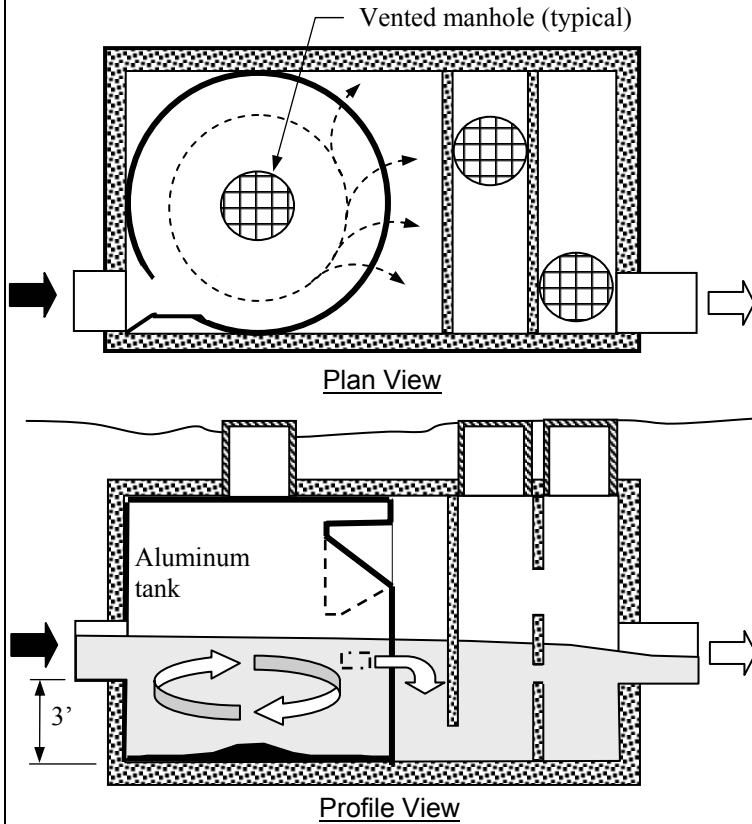

Notes:

1. This figure represents the Vortechs Stormwater Treatment Systems which uses swirl action to settle grit and sediments.
2. Vortechtechnics specifies a ¼” thick aluminum tank for the swirl chamber and 6” thick concrete walls for vault.
3. Inside width = tank diameter Inside length = diameter + 5’ or so Inside height = 6’ to 9’
4. Inlet pipe and outlet pipe may be located on side of structure. A side inlet is optimal for swirling action.
5. Use vented and labeled manhole lids so that the structure is easily identified as an oil/water separator. Vortechtechnics recommends minimum structural design for H-20 vehicle loading.

NOT TO SCALE

**Figure F-02-5
Typical Detail for Swirl Oil/Water Separators**

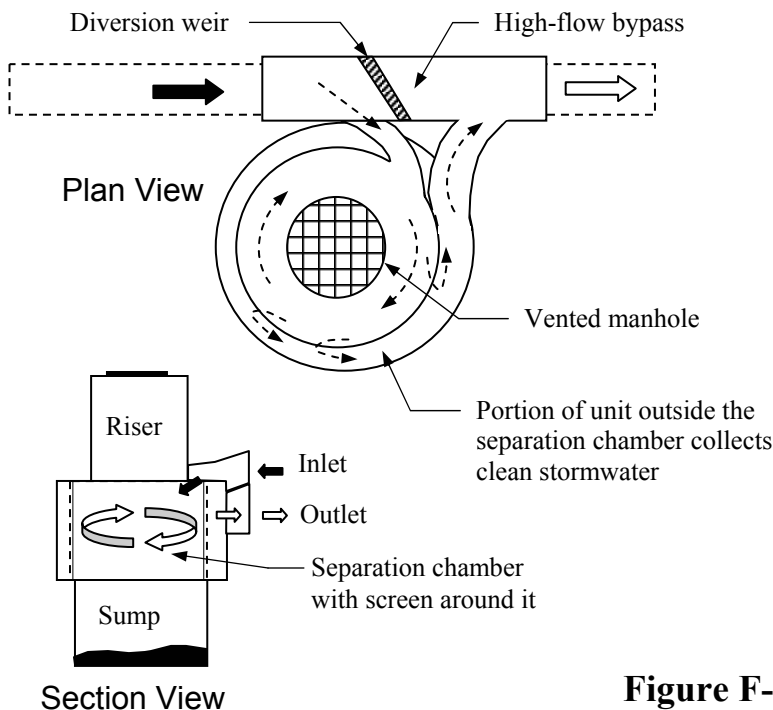

Notes:

1. This figure represents the continuous deflection stormwater treatment as manufactured by CDS Technologies. Units can also be retrofitted onto existing storm drains.
2. Units are manufactured from either fiberglass or precast concrete.
3. Manufacturer recommends the use of sorbent material within CDS separation chamber to improve capture of oil and grease. Usage rate is typically several pounds of sorbent per acre per year.

NOT TO SCALE

**Figure F-02-6
Flow Schematic for Continuous Deflection Separators (CDS Technologies)**

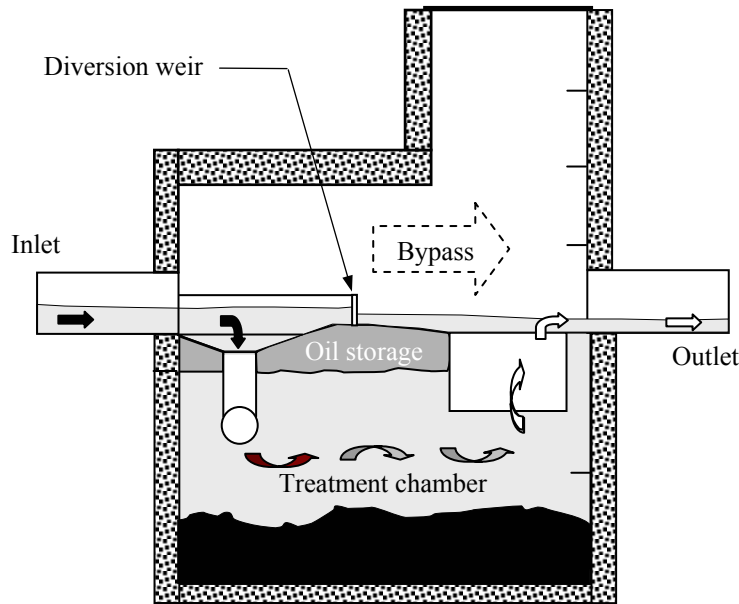

Notes:

1. This figure represents a single-unit system designed to process stormwater runoff on-line, as manufactured by Stormceptor Corporation.
2. Unit consists of an insert placed into a standard concrete manhole. Basic size is 72" diameter, with larger sections used for the treatment chamber as needed.

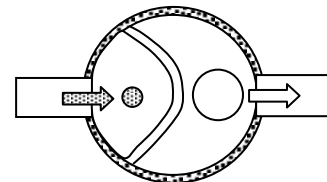

Plan View

NOT TO SCALE

**Figure F-02-7
Oil/Water Separator (Stormceptor)**

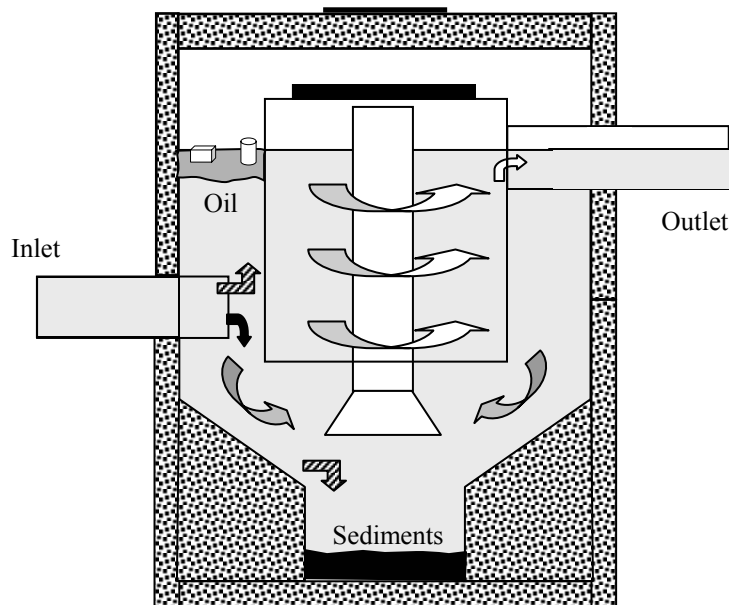

Notes:

1. This figure shows a single unit to treat stormwater runoff, manufactured by H.I.L. Technologies, Inc.
2. Unit consists of polythelyne components supported by a stainless steel frame, inserted into a standard concrete manhole. Concrete manhole sizes vary from 4' to 10'.

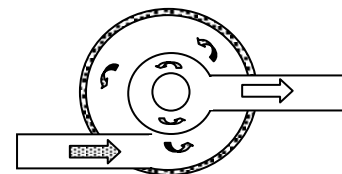

Plan View

NOT TO SCALE

**Figure F-02-8
Oil/Water Separator (Downstream Defender)**

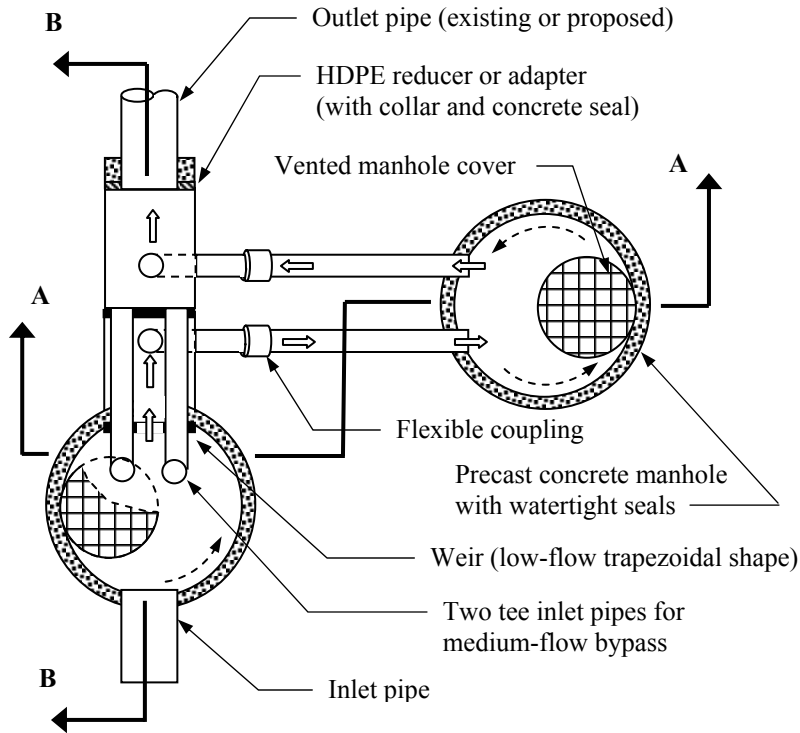

Plan View (with low flow)

Notes:

1. This figure represents the BaySaver separation system, an off-line unit that divides flows into low, medium and high regimes.
2. The unit can be retrofitted onto existing storm drain system or installed as part of a new storm drain system, using two standard precast concrete manholes.

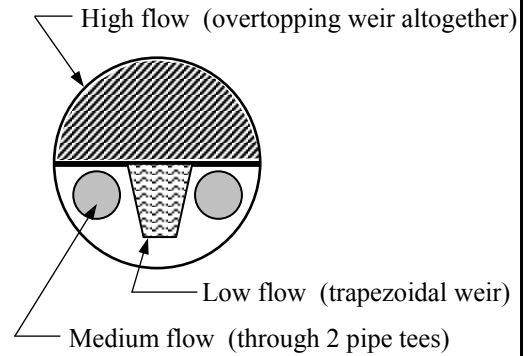

Closeup of Section A-A (flow control)

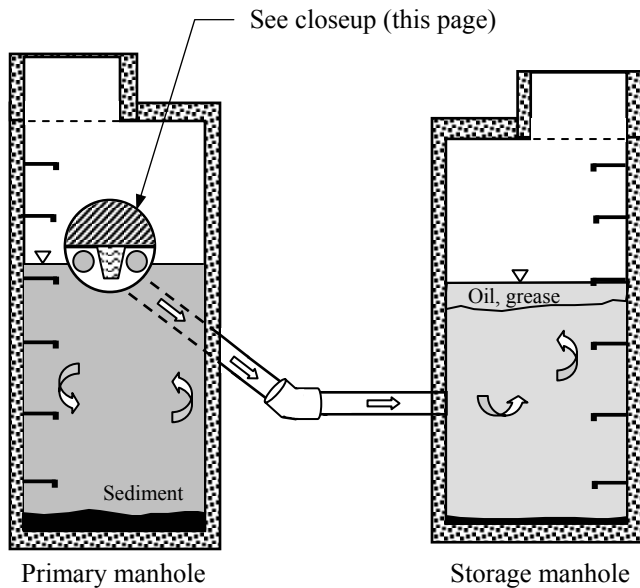

Section A-A (with low flow)

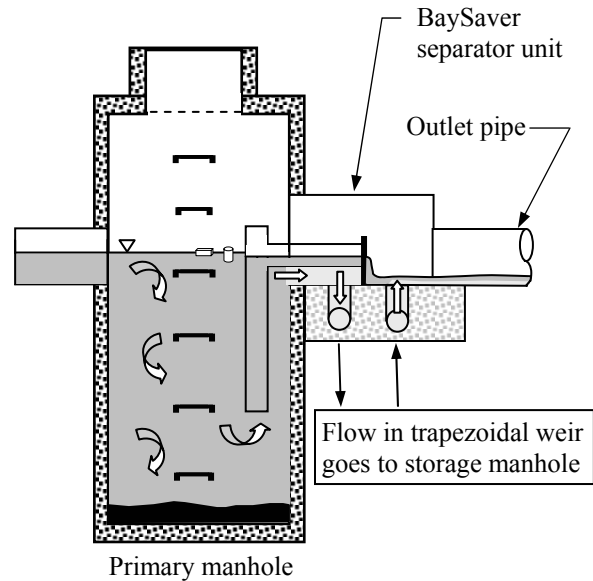

Section B-B (with medium flow)

NOT TO SCALE

**Figure F-02-9
Flow Schematic for Dual Tank System**

References

American Petroleum Institute (API), *Design and Operation of Oil-Water Separators*, Publication 421, 1990.

Branion, R., *Principles for the Separation of Oil Drops from Water in Gravity Type Separators*, Department of Chemical Engineering, University of British Columbia.

Camp Dresser & McKee, Larry Walker Associates, Uribe & Associates, Resources Planning Associates, *Industrial/Commercial Handbook, California Storm Water Best Management Practice Handbooks*, for the California Storm Water Quality Task Force (SWQTF), March 1993.

Camp Dresser & McKee, Woodward-Clyde, Aguilar Engineering, Psomas & Associates, MK Centennial, *Construction Contractors Guide and Specifications, Caltrans Storm Water Quality Handbooks*, prepared for the California Department of Transportation, 1997.

Lettenmaier, D., and J. Richey, *Operational Assessment of a Coalescing Plate Oil/Water Separator*, Municipality of Metropolitan Seattle, 1985.

Metropolitan Washington Council of Governments (MWCOG), *A Current Assessment of Urban Best Management Practices: Techniques for Reducing Nonpoint Source Pollution in the Coastal Zone*, Publication #92705, March 1992.

Silverman, G., *Wetlands for Oil and Grease Control*, Technical Memorandum 87, Association of Bay Area Governments (California), 1982.

Debo, Thomas, and Andrew Reese, *Municipal Storm Water Management*, Lewis Publishers, 1995.

Maine Department of Environmental Protection, *Stormwater Management for Maine: Best Management Practices*, November 1995.

University of Tennessee, Department of Civil & Environmental Engineering, *Soil Erosion Prevention & Sediment Control*, James Smoot and Russell Smith, December 1999.

Vendor Data